

JSimm Passive Backplane

SCH REV	PCB REV	DATE	BY	DESCRIPTION	SCH REV	PCB REV	DATE	BY	DESCRIPTION
0.0		01 May 15	wsk	Schematic capture.					
1.00	1.00	01 May XX	wsk	PCB REV 1 Done.					



TABLE OF CONTENTS

SHEET	TITLE
1	REVISIONS
2	NOTES
3	A GROUP CONNECTORS
4	INTER GROUP TIE
5	B GROUP CONNECTORS
6	POWER SUPPLY

TO DO:

Systronix Inc Proprietary Information.
 This document contains financial, business, scientific, technical, economic or engineering information subject to USC § 1831-1839, Protection of Trade Secrets. Disclosure to others, use, or copying, without the express written authorization of Systronix Inc is strictly prohibited. Violation may result in criminal prosecution under 18 USC § 1831-1839 or 18 USC 1905.
 Copyright 1999, Systronix Inc.
 Unpublished Work. All rights reserved.

SYSTRONIX
 555 SOUTH 300 EAST
 SALT LAKE CITY, UT, USA 84111
 TEL: +1-801-534-1017 FAX: -1019
 WWW.SYSTRONIX.COM INFO@SYSTRONIX.COM

Title JSimm Passive Backplane REVISIONS		
Size	Number	Rev
B		0.00
Date Thu May 31, 2001	Drawn by wsk	
Filename JSimm Passive Backplane	Sheet 01	of 6

NOTES

1 JSimm pin definition is compliant with the SimmStick (TM) specification.

! 2 SimmStick (TM) specification for pin 4 PWR, is 7.5 - 18Vdc.

2

1

1

2

2

3

3

4

4

SYSTRONIX
555 SOUTH 300 EAST
SALT LAKE CITY, UT, USA 84111
TEL: +1-801-534-1017 FAX: -1019
WWW.SYSTRONIX.COM INFO@SYSTRONIX.COM

Title JSimm Passive Backplane NOTES		
Size	Number	Rev
B		0.00
Date Thu May 31, 2001	Drawn by wsk	
Filename JSimm Passive Backplane	Sheet 02 of 6	

A

B

C

D

A

B

C

D

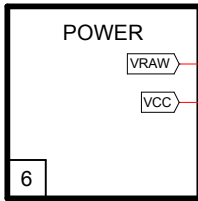
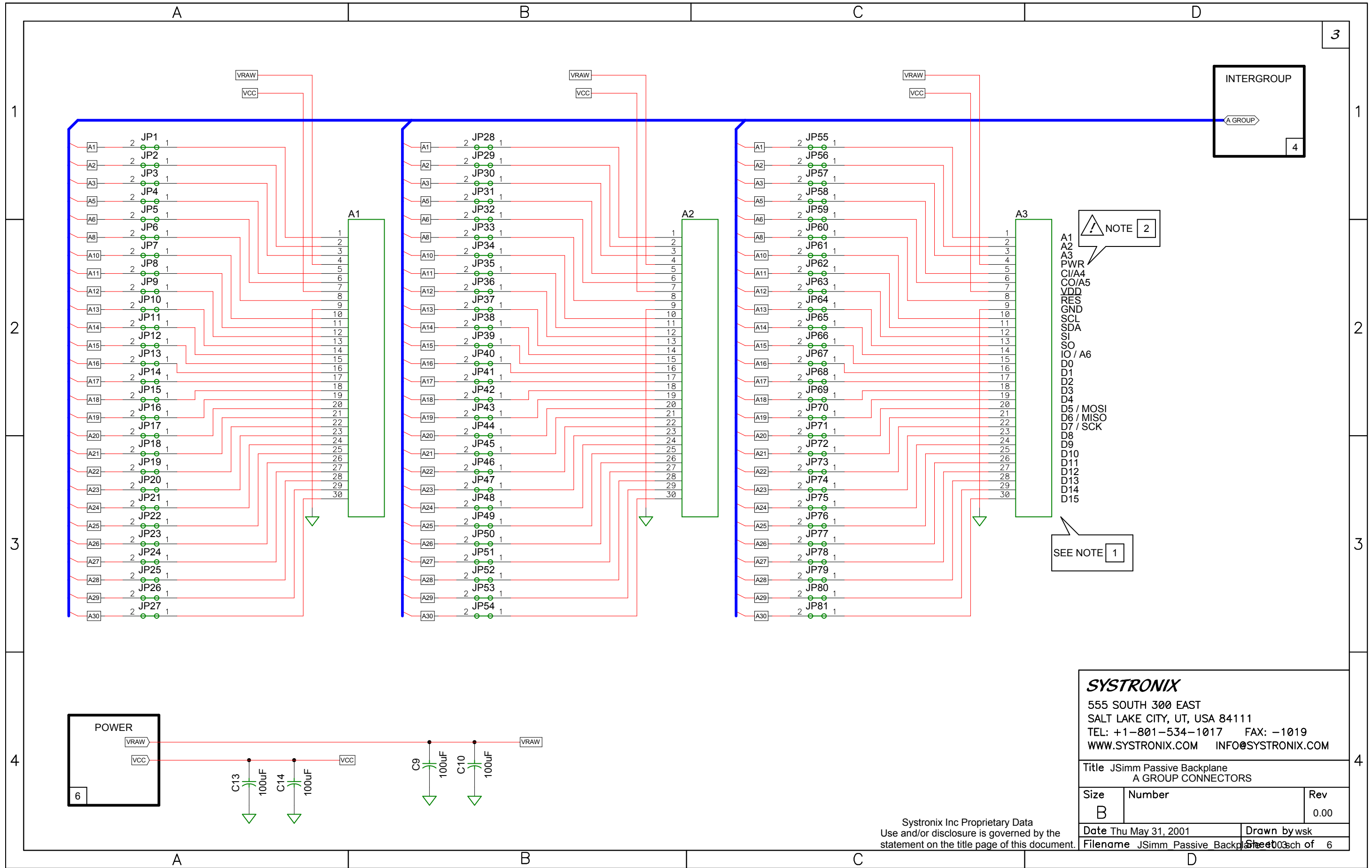

SYSTRONIX
 555 SOUTH 300 EAST
 SALT LAKE CITY, UT, USA 84111
 TEL: +1-801-534-1017 FAX: -1019
 WWW.SYSTRONIX.COM INFO@SYSTRONIX.COM

Title JSimm Passive Backplane A GROUP CONNECTORS		
Size B	Number	Rev 0.00
Date Thu May 31, 2001	Drawn by wsk	
Filename JSimm Passive Backplane	Sheet 03 of 6	

Systronix Inc Proprietary Data
 Use and/or disclosure is governed by the
 statement on the title page of this document.

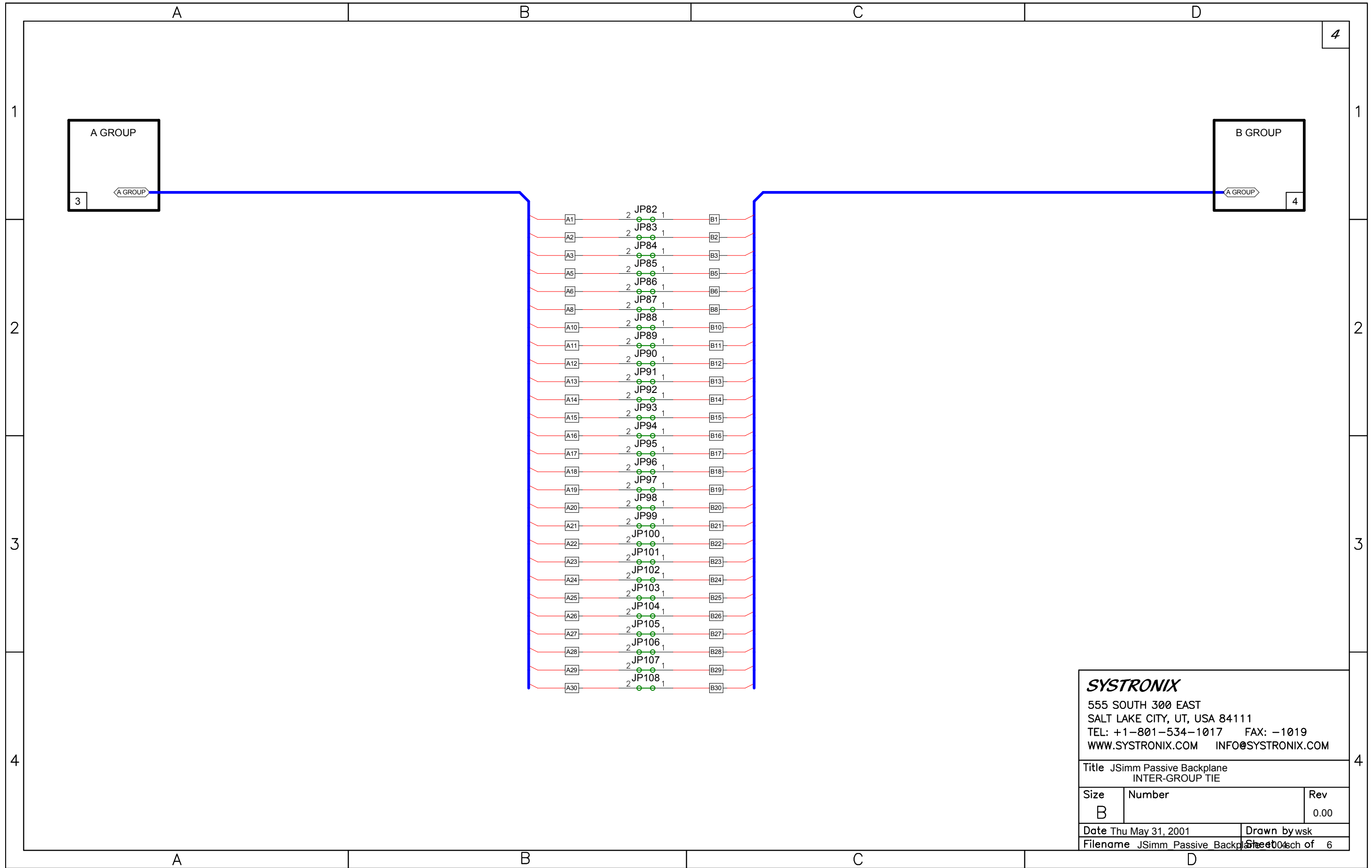

SYSTRONIX		
555 SOUTH 300 EAST SALT LAKE CITY, UT, USA 84111 TEL: +1-801-534-1017 FAX: -1019 WWW.SYSTRONIX.COM INFO@SYSTRONIX.COM		
Title JSimm Passive Backplane INTER-GROUP TIE		
Size	Number	Rev
B		0.00
Date	Thu May 31, 2001	Drawn by wsk
Filename	JSimm Passive Backplane	Sheet 04 of 6

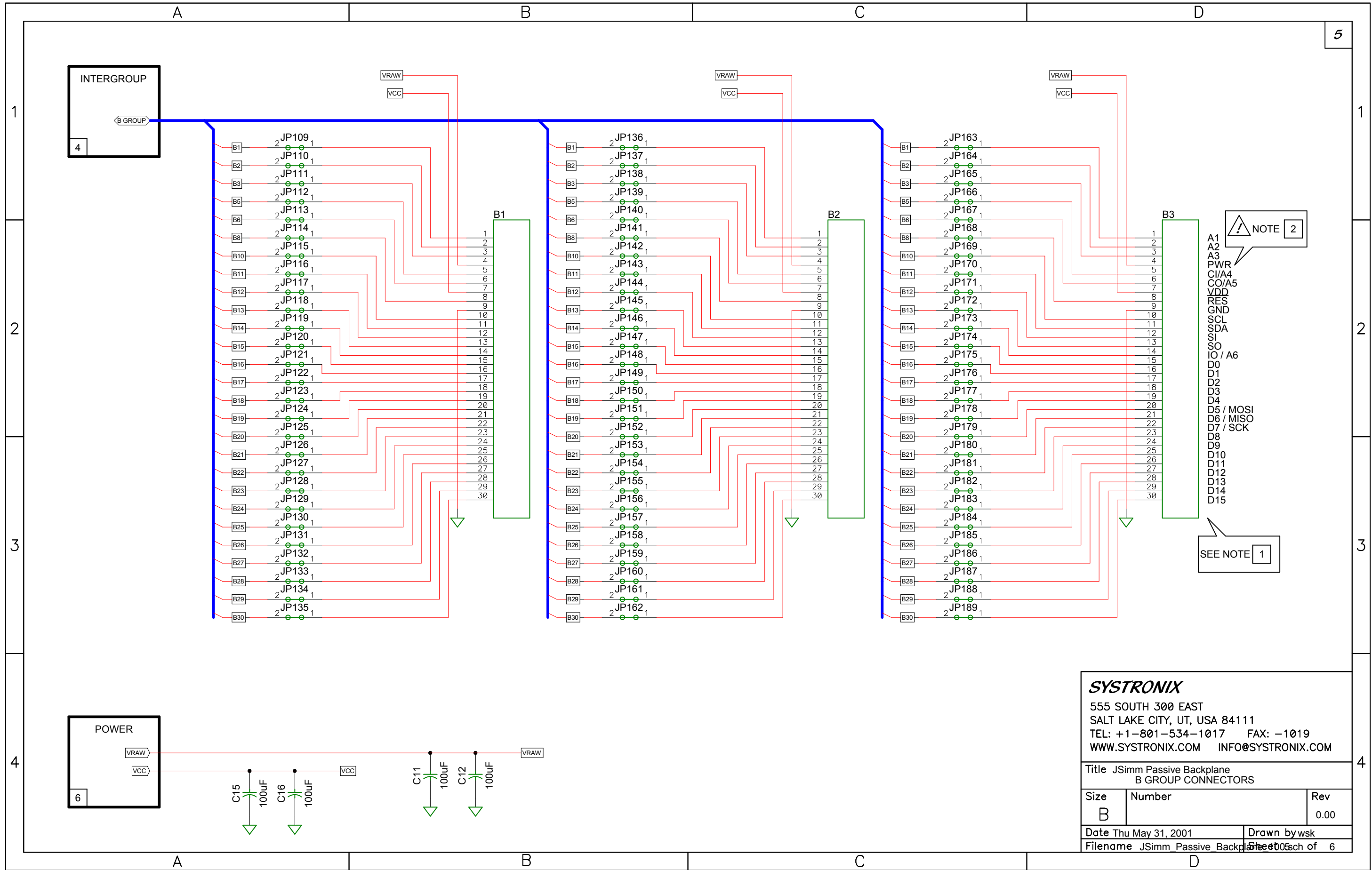

SYSTRONIX
 555 SOUTH 300 EAST
 SALT LAKE CITY, UT, USA 84111
 TEL: +1-801-534-1017 FAX: -1019
 WWW.SYSTRONIX.COM INFO@SYSTRONIX.COM

Title JSimm Passive Backplane B GROUP CONNECTORS		
Size B	Number	Rev 0.00
Date Thu May 31, 2001	Drawn by wsk	
Filename JSimm Passive Backplane	Sheet 05 of 6	

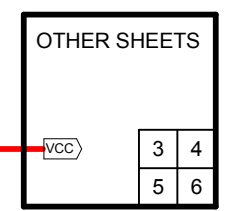
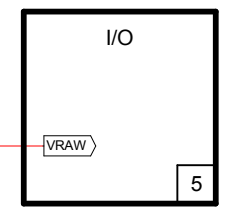
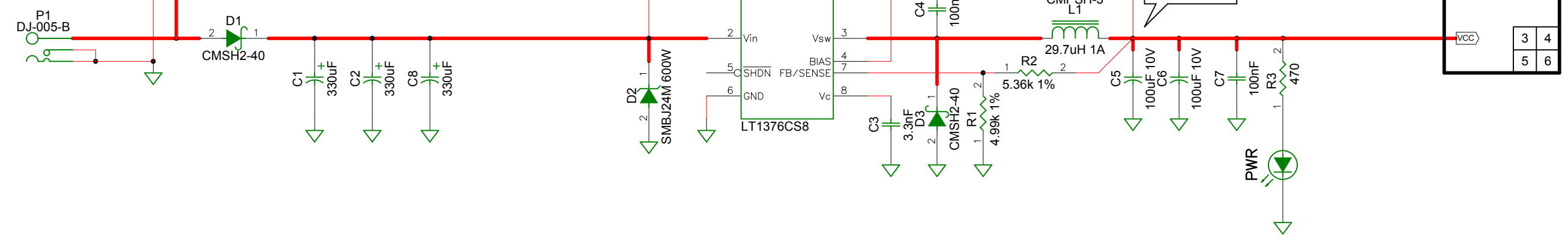
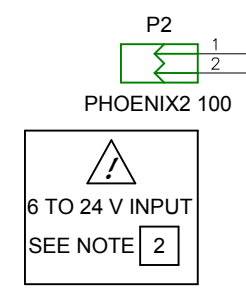

SYSTRONIX
 555 SOUTH 300 EAST
 SALT LAKE CITY, UT, USA 84111
 TEL: +1-801-534-1017 FAX: -1019
 WWW.SYSTRONIX.COM INFO@SYSTRONIX.COM

Title JSimm Passive Backplane
POWER SUPPLY

Size	Number	Rev
B		0.00

Date Thu May 31, 2001 Drawn by wsk
 Filename JSimm Passive Backplane Sheet 06 of 6